

Fan Arrangements, Rotation, Discharge and Motor Position

Introduction

Fan arrangements and classes are industry standards that have been determined by AMCA (Air Movement and Control Association) to communicate the operating condition that a fan is capable of, the location of the bearings and drive configurations.

Drive Arrangements for Centrifugal Fans

Adapted from AMCA Standard 99-2404-03, with written permission from Air Movement and Control Association International, Inc.

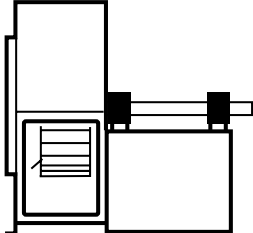
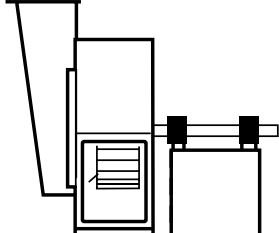
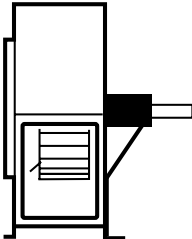
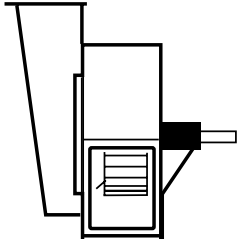
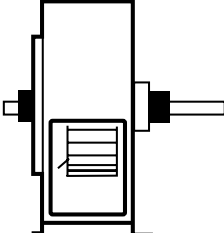
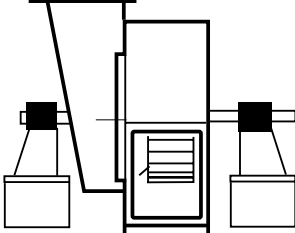
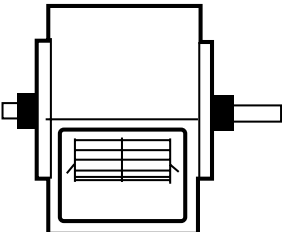
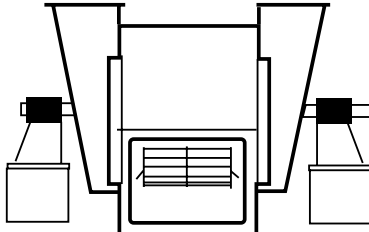
<u>Description</u>	<u>Fan Configuration</u>	<u>Alternative Fan Configuration</u>
<p>Arrangement 1 SWSI For belt or direct drive. Impeller overhung on shaft, two bearings mounted on pedestal base. Alternative: Bearings mounted on independent pedestals, with or without inlet box.</p>		
<p>Arrangement 2 SWSI For belt or direct drive. Impeller overhung on shaft, bearings mounted in bracket supported by the fan casing. Alternative: With inlet box.</p>		
<p>Arrangement 3 SWSI For belt or direct drive. Impeller mounted on shaft between bearings supported by the fan casing. Alternative: Bearings mounted on independent pedestals with inlet box and designated as Arr. 3 SI.</p>		
<p>Arrangement 3 DWDI For belt or direct drive. Impeller mounted on shaft between bearings supported by the fan casing. Alternative: Bearings mounted on independent pedestals with inlet box and designated as Arr. 3 DI.</p>		

Drive Arrangements for Centrifugal Fans (continued)

Description

Fan Configuration

Alternative Fan Configuration

Arrangement 4 SWSI

For direct drive. Impeller overhung on motor shaft. No bearings on fan. Motor mounted on base. Alternative: With inlet box.

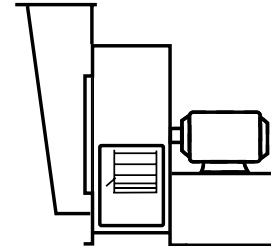
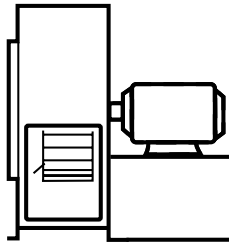

Arrangement 7 SWSI

For coupling drive. Generally the same as Arrangement 3, with base for the prime mover. Alternative: Bearings mounted on independent pedestals with inlet box and designated as Arr. 7 SI.

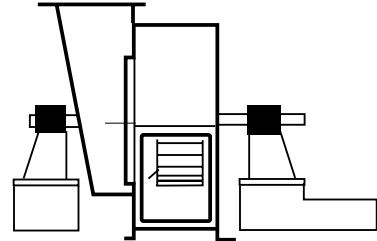
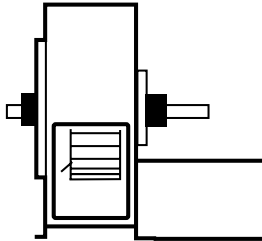

Arrangement 7 DWDI

For coupling drive. Generally the same as Arrangement 3, with base for the prime mover. Alternative: Bearings mounted on independent pedestals with inlet box and designated as Arr. 7 SI.

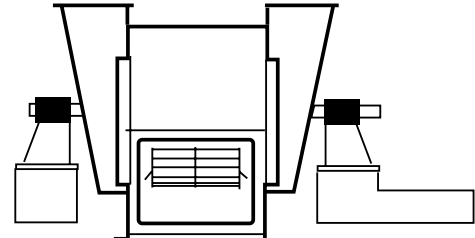
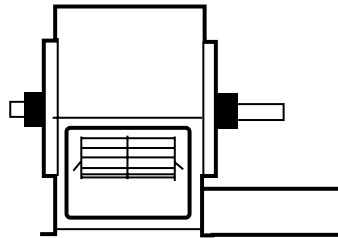

Arrangement 8 SWSI

For direct drive. Generally the same as Arrangement 1, with base for the prime mover. Alternative: Bearings mounted on independent pedestals, with or without inlet box.

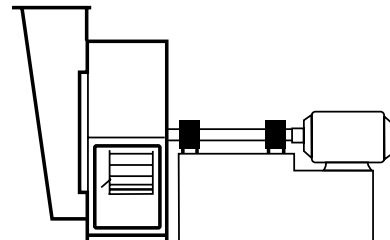
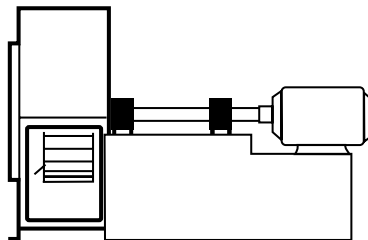

Arrangement 9 SWSI

For belt drive. Impeller overhung on shaft, two bearings mounted on pedestal base. Motor mounted on the outside of the bearing base. Alternative: With inlet box.

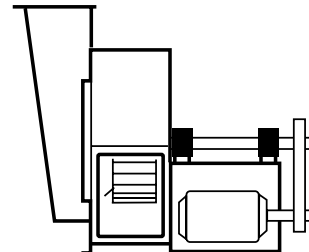
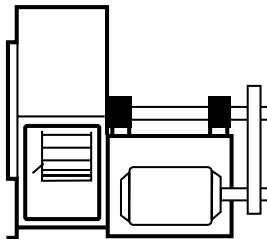

Arrangement 10 SWSI

For belt drive. Generally the same as Arrangement 9 with motor mounted inside of the bearing pedestal. Alternative: With inlet box.

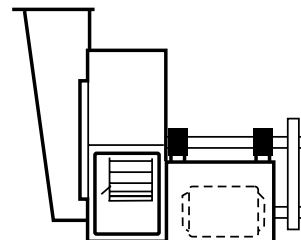
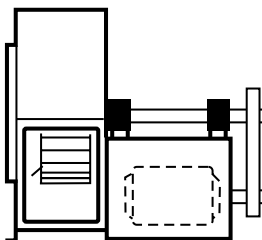

Drive Arrangements for Tubular Centrifugal Fans

Adapted from AMCA Standard 99-2410-03, with written permission from Air Movement and Control Association International, Inc.

Description

Arrangement 1

For belt drive. Impeller overhung on a shaft supported by bearings mounted within casing. Motor mounted independent of casing. Horizontal discharge.

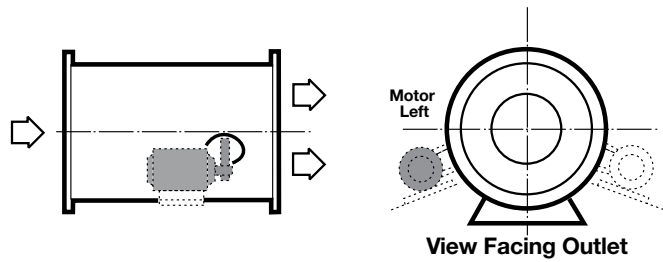

Arrangement 3

For belt drive. Impeller center-hung on a shaft supported by bearings mounted within casing. Designed for mounting of motor on outside of casing in one of the standard locations shown. For horizontal and vertical discharge. Duct mounting shown.

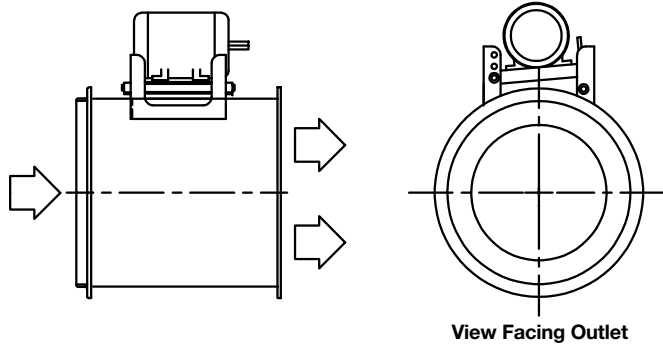

Arrangement 4

For direct drive. Impeller overhung on motor shaft. Motor supported within casing. For horizontal or vertical discharge. Duct mounting shown.

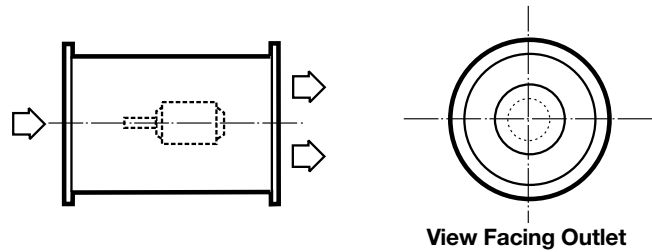

Arrangement 9

For belt drive. Impeller overhung on a shaft supported by bearings mounted within casing. Designed for mounting of motor on outside of casing in one of the standard locations shown. For horizontal and vertical discharge. Duct mounting shown.

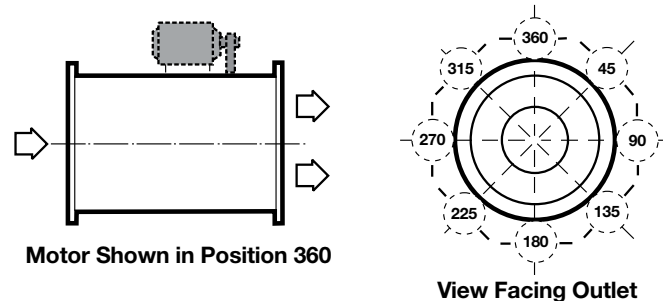

Arrow designates the direction of airflow.

Rotation of fans is determined by viewing from the fan outlet end.

Specify either upblast or downblast discharge for vertically-mounted fans.

The locations of motors, supports, access doors, etc., are determined by viewing the outlet of the fan and resting location 180° on the floor as shown for Arrangement 9.

Arrangements 4 and 9 can be furnished with supports for floor, wall or ceiling mounting. The position of these supports determines which motor locations are available for motor placement. Generally, motor locations 135°, 180° and 225° are not available on floor, wall or inverted ceiling-mounted fans and motor locations 45°, 90°, 270° and 315° may not be available for ceiling-hung fans.

Another method of mounting vertical fans is shown in the view on the right. Specify fan to be furnished with ceiling-mounting brackets, floor mounting brackets or both.

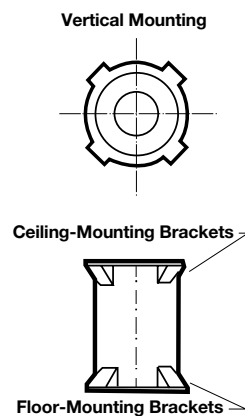

Drive Arrangements for Axial Fans

Adapted from AMCA Standard 99-3404-03, with written permission from Air Movement and Control Association International, Inc.

Description

Fan Configuration

Alternative Fan Configuration

Arrangement 1

For belt or direct drive. Impeller overhung on shaft, two bearings mounted either upstream or downstream of the impeller.

Alternative: Single stage or two stage fans can be supplied with inlet box and/or discharge evase.

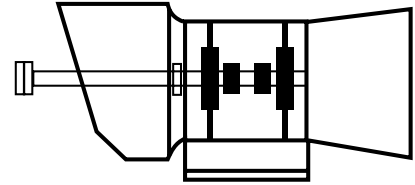
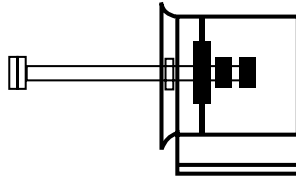

Arrangement 3

For belt or direct drive. Impeller mounted on shaft between bearings on internal supports.

Alternative: Fan can be supplied with inlet box and/or discharge evase.

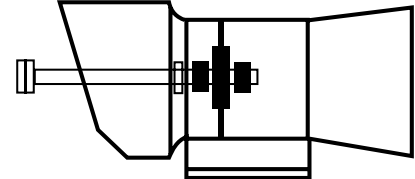
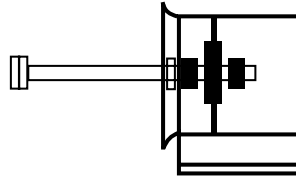

Arrangement 4

For direct drive. Impeller overhung on motor shaft. No bearings on fan. Motor mounted on base or integrally mounted.

Alternative: With inlet box and/or discharge evase.

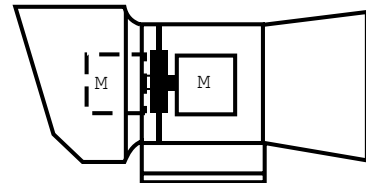
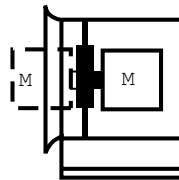

Arrangement 7

For direct drive. Generally the same as Arrangement 3 with base for the prime mover.

Alternative: With inlet box and/or discharge evase.

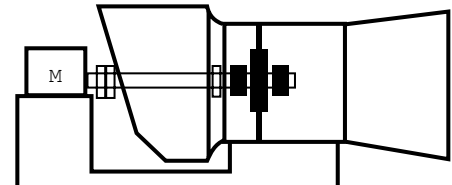
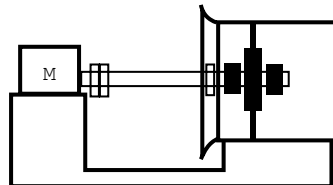

Arrangement 8

For direct drive. Generally the same as Arrangement 1 with base for the prime mover.

Alternative: Single stage or two stage fans can be supplied with inlet box and/or discharge evase.

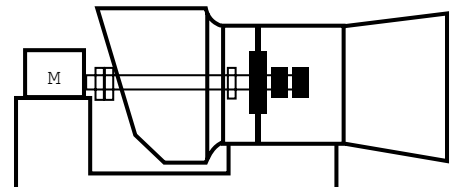
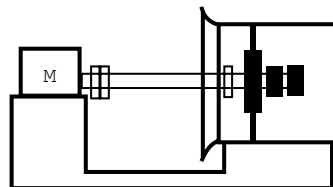

Arrangement 9

For belt drive. Generally the same as Arrangement 1 with motor mounted on fan casing and/or an integral base.

Alternative: With inlet box and/or discharge evase.

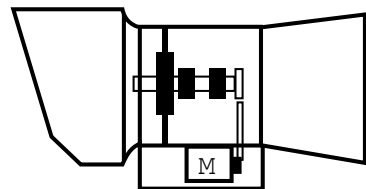
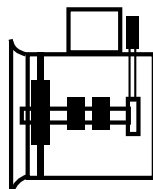

Non-AMCA Specified Arrangements

Arrangement 3F DWDI or SWSI

Standard arrangement 3 DWDI/SWSI fan with integral “floor” motor mount. Additional convenience of motor mounted on integral sub-base, for mounting on vibration isolators, generally springs.

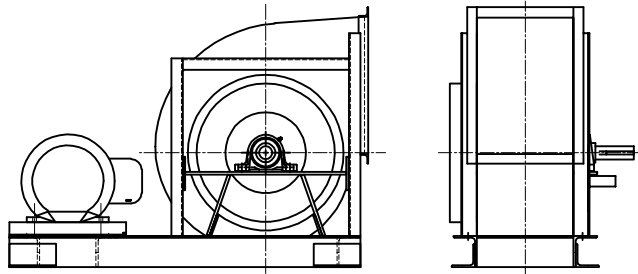

Arrangement 9F

Standard arrangement 9 SWSI fan with integral “floor” motor mount. Additional convenience of motor mounted on integral sub-base. Intended for rigid floor mounting.

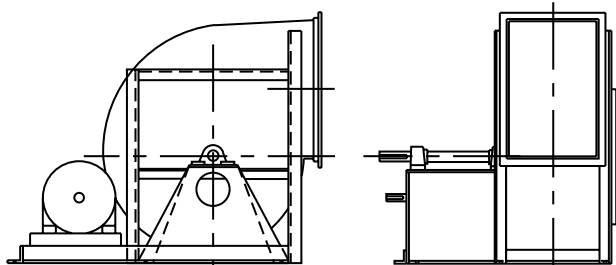

Advantages and Disadvantages of Fan Arrangements

Arrangement 1

Allows versatility, can be direct or belt driven with the motor mounted on a separate pedestal. Bearings out of the airstream allow for high temperature operation. The option of using belt drives allows for speed adjustment in case of a performance deficit. The motor must be mounted separately or a unitary base is provided.

Arrangement 2

Same as Arrangement 1, as far as direct or belt driven and speed adjustment through drive change. In addition, the pedestal bearing is shorter, which makes a smaller assembly. A shorter pedestal is less robust at high fan speeds, therefore Arrangement 2 should be used for low speed fans only. The motor must be mounted separately or a unitary base is provided.

Arrangement 3

Does not have a pedestal. Bearings are mounted in the inlet and drive, usually on a bearing “bar,” so it has a small footprint. Can be direct or belt driven. Bearings in the airstream restrict the airstream temperature to about 130°F. The motor must be mounted separately or a unitary base is provided. Bearings may be moved out of the airstream by using inlet boxes but this increases the size of the footprint.

Arrangement 4

Mounting the impeller on the motor makes a compact assembly, but restricts airstream temperature to about 180°F. (The airstream temperature will be passed directly to the motor shaft and bearings.) Generally, Arrangement 4 must only be used with small fan impellers.

Arrangement 7

Similar to the Arrangement 3, Arrangement 7 does not have a bearing pedestal, small footprint, or direct drive, so speed up must be achieved by using a variable speed device (ie. VFD). Limited to 130° F unless inlet boxes are used. A motor pedestal may be incorporated in the fan structure.

Arrangement 8

Offers the same benefits regarding high temperature as Arrangement 1. The motor pedestal is incorporated into the fan structure.

Arrangement 9

Speed changes are possible since a belt drive is used. The motor is mounted on the side of the pedestal to make the fan and driver a compact unit. Larger motors cannot be mounted in this arrangement or special provisions must be made.

Arrangement 10

Provides the benefits of belt driven units. The fan and motor are mounted as a compact unit with the motor inside the bearing pedestal. This arrangement is usually used with small- to mid-sized fans and motors.

Special Considerations

Impeller Rotation - Axial Products

Impeller rotation is always observed from the discharge regardless of where the impeller is mounted, which could be either at the inlet or the discharge.

Fan Discharge Connections - Downblast Discharge (DBD)

Connections to the discharge of DBD fans can be difficult, since the flange is usually located at the foundation bolting level. Some methods of dealing with this include:

1. Using a flex connection to go through a floor or base
2. Changing the centerline height of the fan to raise the discharge flange off of the floor
3. Incorporating discharge flange bolting into the base or floor on which the fan is mounted

Inlet Box Positions for Centrifugal Fans

Adapted from AMCA Standard 99-2405-03, with written permission from Air Movement and Control Association International, Inc.

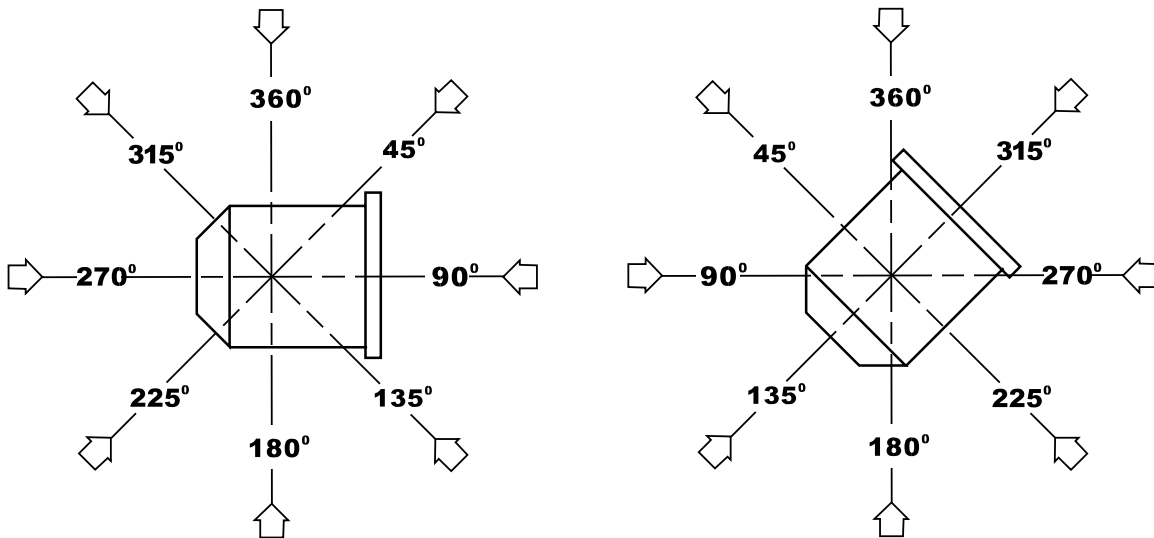

**CLOCKWISE
FAN ROTATION
(90° Inlet Box Position Shown)**

**COUNTERCLOCKWISE
FAN ROTATION
(315° Inlet Box Position Shown)**

Opening towards fan housing not shown and may be on either side of box

Notes:

1. Position of inlet box and air entry to inlet box is determined from the drive side as defined below:
 - a. On single inlet fans: The drive side is that side which is opposite of the fan inlet.
 - b. On double inlet fans:
 1. With a single driver: That side with the driver is considered as the drive side.
 2. With multiple drivers: That side with the higher total power is considered as the drive side. If the total power on each side is equal, then the side that has the fixed (non-expansion) bearing is considered as the drive side.
2. Position of inlet box is determined in accordance with diagrams. Angle of air entry to box is referred to the top vertical axis of fan in degrees as measured in the direction of fan rotation. Angle of air entry to box may be any intermediate angle as required.
3. Positions 135° to 225° in some cases may interfere with floor structure.

Designation for Rotation and Discharge of Centrifugal Fans

Adapted from AMCA Standard 99-2406-03, with written permission from Air Movement and Control Association International, Inc.

Clockwise Up Blast CW 360	Clockwise Top Angular Up CW 45	Clockwise Top Horizontal CW 90	Clockwise Top Angular Down CW 135	Clockwise Down Blast CW 180	Clockwise Bottom Angular Down CW 225	Clockwise Bottom Horizontal CW 270	Clockwise Bottom Angular Up XW 315
Counterclockwise Up Blast CCW 360	Counterclockwise Top Angular Up CCW 45	Counterclockwise Top Horizontal CCW 90	Counterclockwise Top Angular Down CCW 135	Counterclockwise Down Blast CCW 180	Counterclockwise Bottom Angular Down CCW 225	Counterclockwise Bottom Horizontal CCW 270	Counterclockwise Bottom Angular Up CCW 315

Notes:

- Direction of rotation and angular reference is determined from the drive side as defined below:
 - On single inlet fans: The drive side is that side which is opposite of the fan inlet.
 - On double inlet fans:
 - With a single driver: That side with the driver is considered as the drive side.
 - With multiple drivers: That side with the higher total power is considered as the drive side. If the total power on each side is equal, then the side that has the fixed (non-expansion) bearing is considered as the drive side.
- Direction of discharge is determined in accordance with diagrams. Angle of discharge is referred to the top vertical axis of fan and designated in degrees as measured in the direction of fan rotation. Angle of discharge may be any intermediate angle as required.
- A fan inverted for ceiling suspension or rotated for side wall mounting will have its direction of rotation and angle of discharge determined when fan is located as if floor mounted.
- This standard is in harmony with ISO 13349. In ISO 13349, CCW fans are referred to as LG, i.e. Left or Gauche, while CW fans are referred to as RD, i.e. Right or Droit-handed rotation.

Methods of Designation of the Angular Position of Component Parts of a Centrifugal Fan

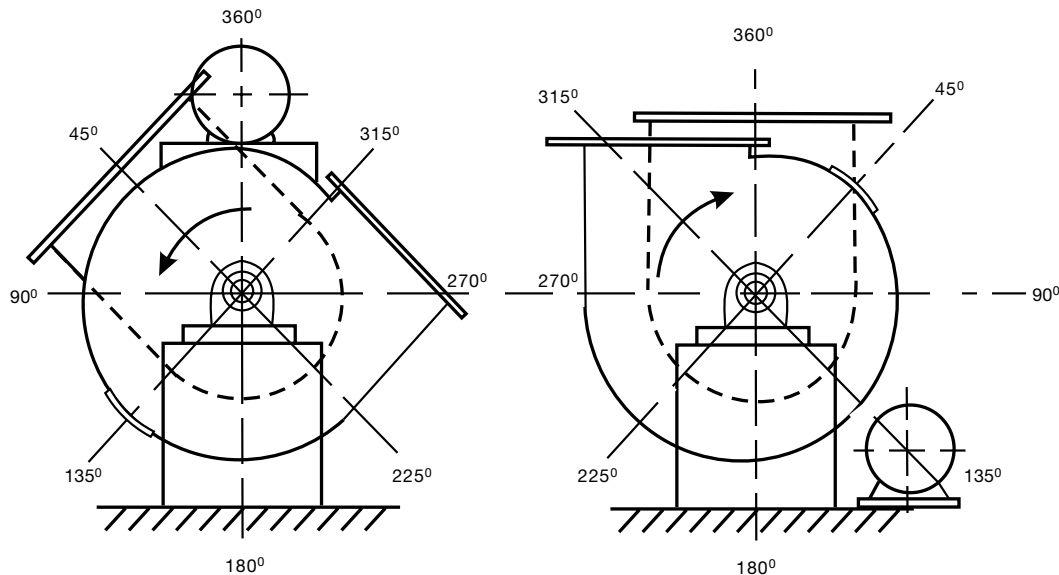

CCW Example 1

Outlet	CCW	315°
Inspection door	CCW	135°
Inlet box	CCW	45°
Motor	CCW	360°

CW Example 2

Outlet	CW	360°
Inspection door	CW	45°
Inlet box	CW	360°
Motor	CW	135°

Uncommon Inlet/Discharge Angles

Inlet boxes and fan discharges may be provided at odd angles if requested. For example, a 30° inlet box position for a clockwise rotation fan with fan discharge at 330°.

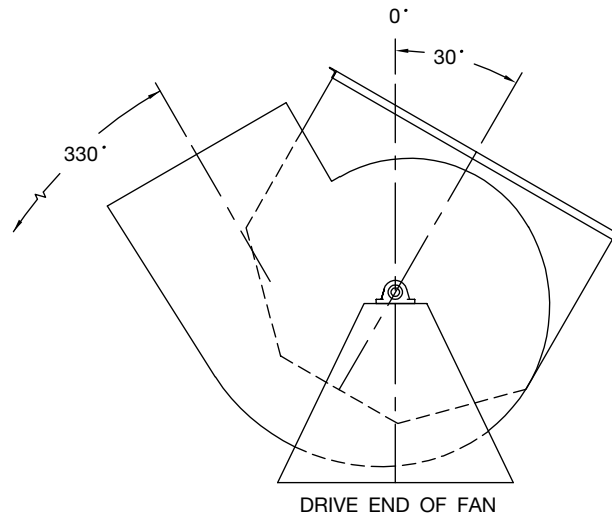

Motor Positions for Belt Driven Centrifugal Fans

Adapted from AMCA Standard 99-2407-03, with written permission from Air Movement and Control Association International, Inc.

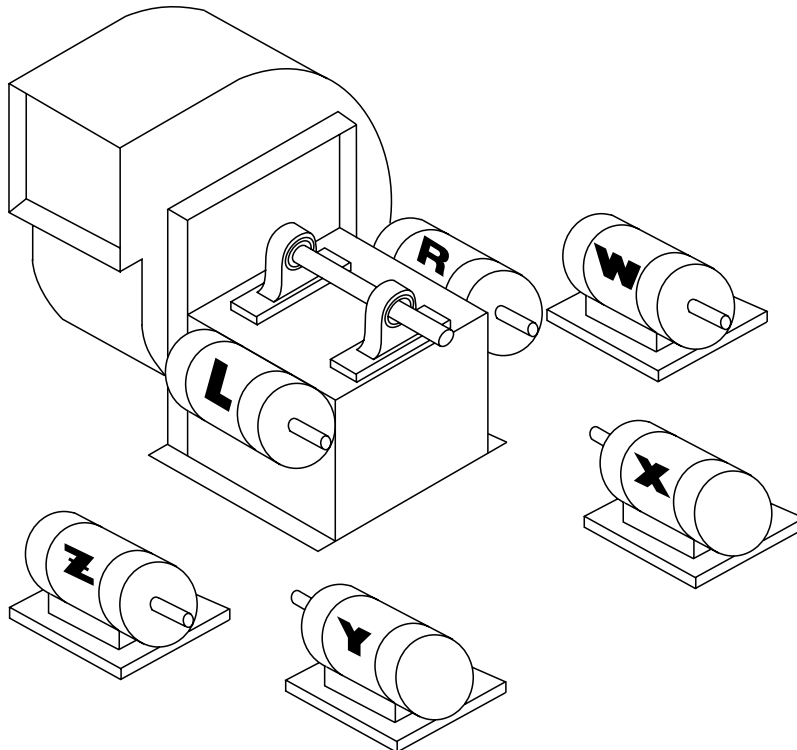

Location of motor is determined by facing the drive side of the fan and designating the motor position by letters W, X, Y or Z as the case may be.



202 COMMERCE WAY | PULASKI, TN 38478 | (931) 424-2500

WWW.CLARAGE.COM

©2021 TWIN CITY FAN COMPANIES, LTD.